

Bludee ATF-102 USER MANUAL

INDEX

SPECIFICATIONS-----	2
FUNCTION TABLE-----	3
PART DESCRIPTION-----	4
OPERATION PREPARATIONS-----	5
FLUSH-----	6
EXCHANGE-----	7
ADJUST (INCREASE)-----	8
ADJUST(DECREASE)-----	9
DRAIN-----	10
SETTING-----	11
UPDATE-----	13
MAIN TROUBLESHOOTING-----	14
ADAPTOR LIST-----	15

Specifications:

- Dimensions: unpacked machine: 635*585*1075mm³
- Power supply: 110V 60Hz
- Output: 200W
- Automatic identification of out and return direction
- Length of out and return hose: 3m
- Drainage hose: 1m
- Capacity of old/new fluid drum: 25L
- Load cell range: 80kg
- Exchange accuracy: ±100ml
- Detergent bottle capacity: 500ml
- LCD display: 105.5*67.2mm, 480RGB x 272 Dots ,TFT full color
- Pressure gauge range: 0~150psi (1-10Bar)

Function Table

Main function	Flush	Add detergent to A/T system. Just with equipment connected to A/T, even turned off, can perform flush function.
	Exchange	Accurately take out used fluid from A/T system, meanwhile charge new fluid to the system.
	Adjust	Increase or decrease ATF level of the A/T system
	Drain	Empty the new fluid drum or used fluid drum of the equipment
Setting	Calibration	Calibration of new and used fluid drum load cell.
	Language	Select different languages
	Weight set	Set weight of empty new and used drum.
	Diagnose	By activating/des-activating pump or solenoids, diagnose work status of the equipment

Part description

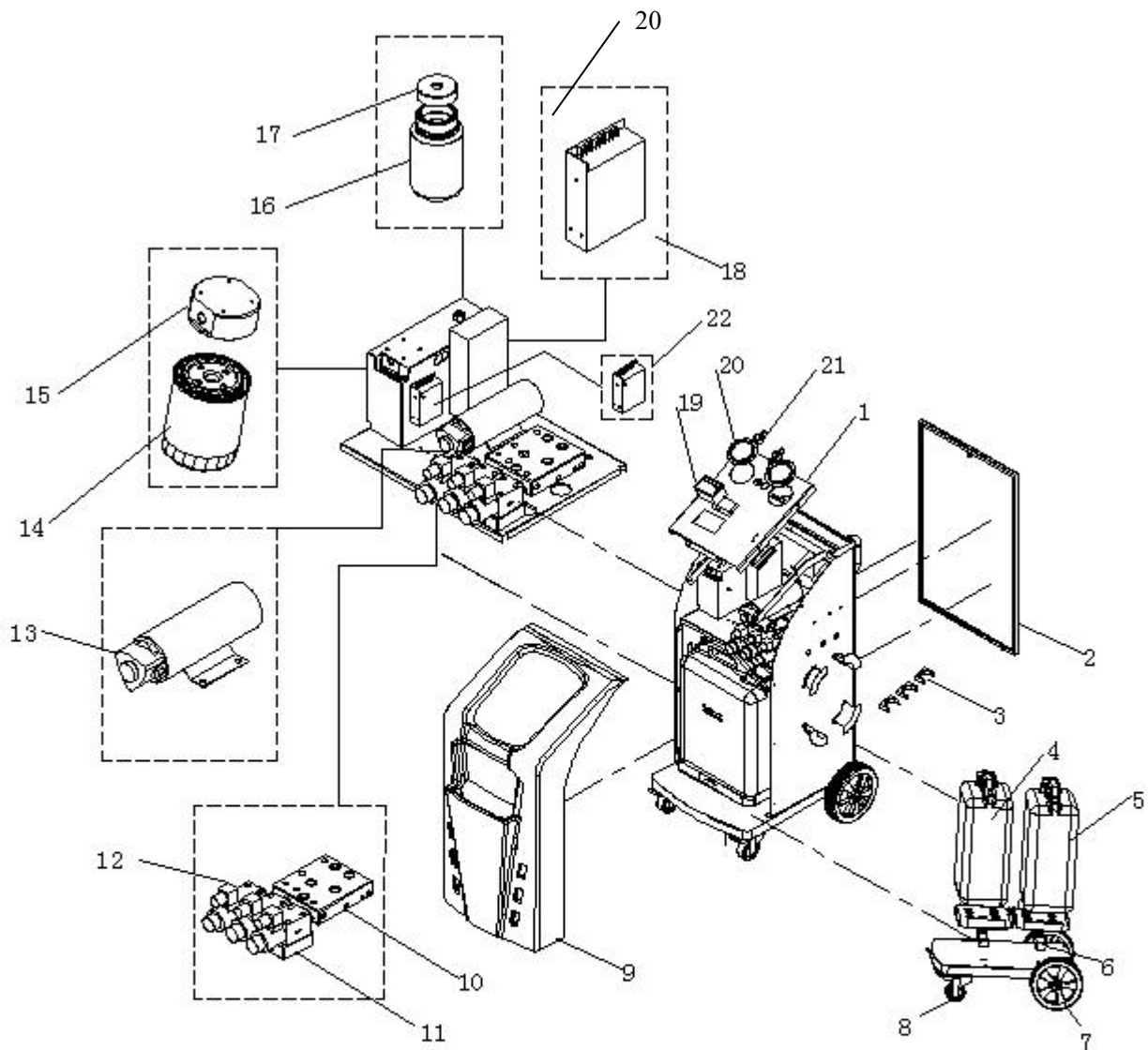

No.	Name	No.	Name	No.	Name	No.	Name
1	Upper cover	7	Rear wheel	13	Oil pump	19	Printer
2	Back cover	8	Front wheel	14	Filter	20	pressure gauge
3	Hose holder	9	Front cover(plastic)	15	Filter base	21	Humidity
4	Used fluid drum	10	Manifold assembly 2	16	Detergent bottle	22	Power
5	New fluid drum	11	Manifold assembly 1	17	Detergent bottle support		
6	Load cell	12	Solenoid	18	Power		

Operation preparations

1. Park the car well, lift the car with drive wheels hang in the air (Pic.2).

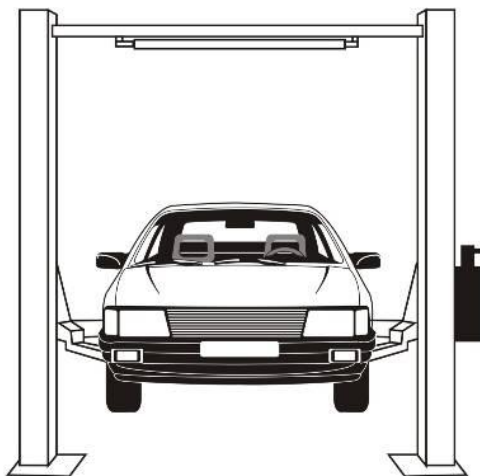

Pic. 2

Note: Drive wheels must be hung in the air without touching anything.

2. Connect the hoses with reference to the following picture (Pic.3)

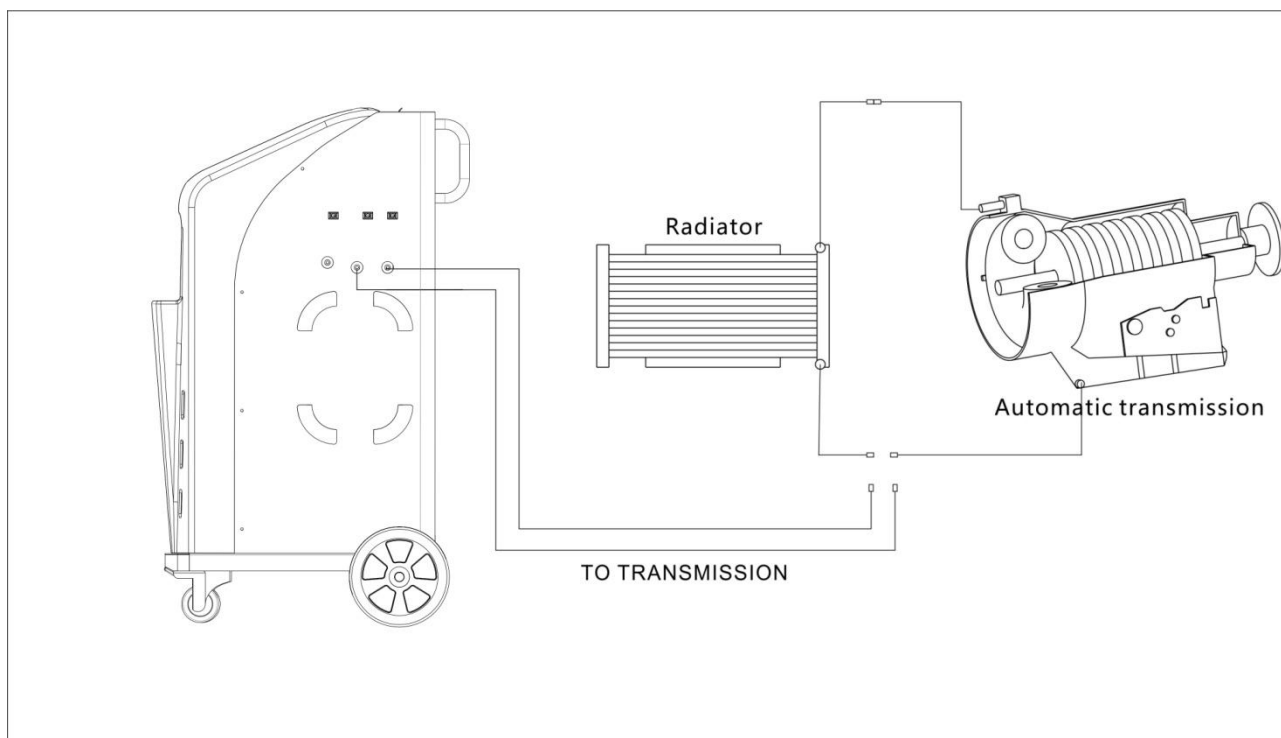

Pic. 3 Hose connection

3. Fill the equipment new fluid drum with certain amount of ATF (It is recommended to add 1-2L more than the automotive standard ATF volume, refer to the automotive manual for standard volume)
4. If need to run flush function, fill detergent bottle with detergent.
5. Before run exchange function, check if there is old fluid in the old fluid drum. Need to drain the old fluid drum in case the balanced capacity is not enough for the old fluid to be exchanged

Flush

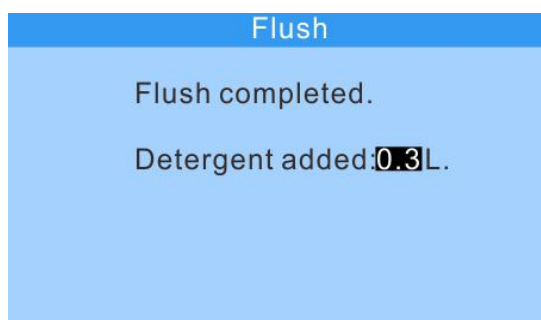
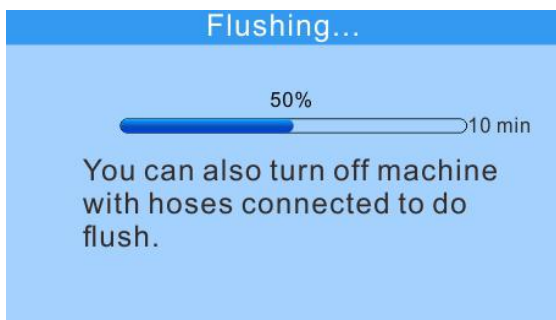
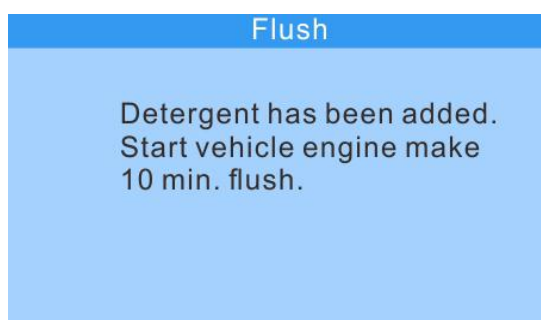
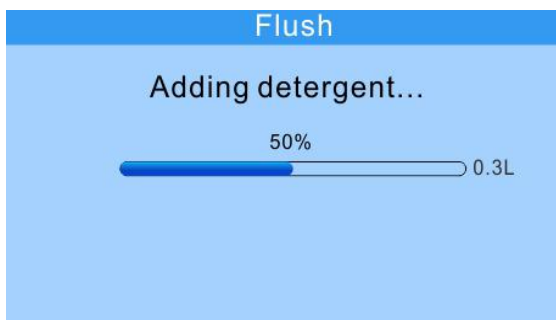
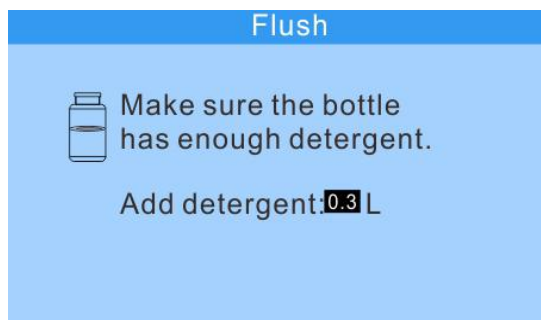
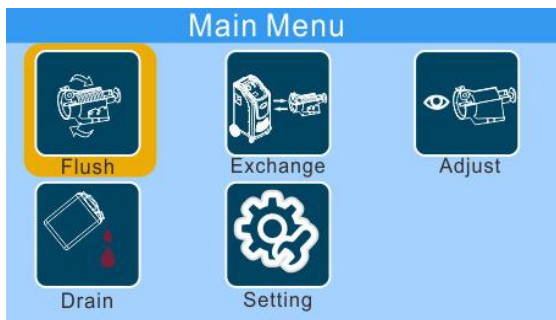

Exchange

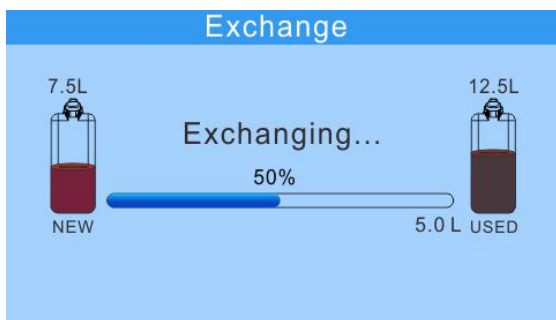
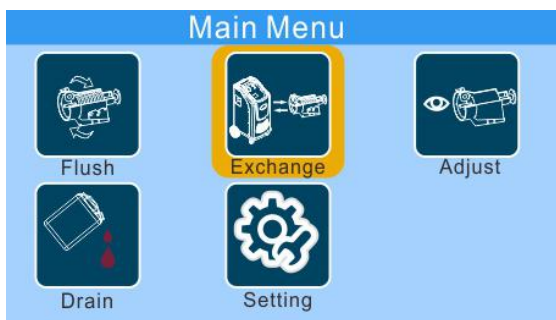

Remarks: Before exchange, if used fluid tank is full, or new fluid tank is empty, the machine will automatically make alarm and remind to drain used fluid tank, or fill new fluid tank.

Adjust (Increase)

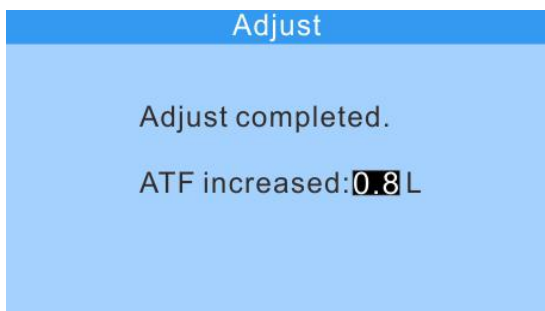
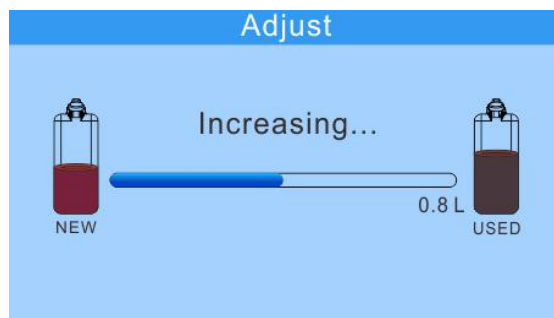
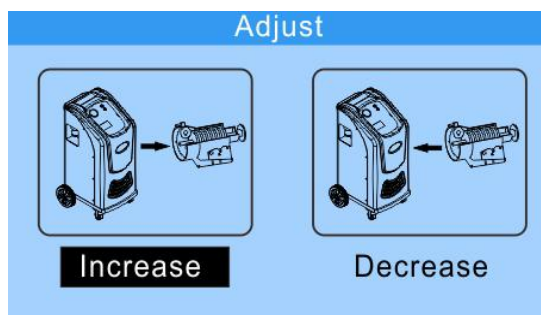
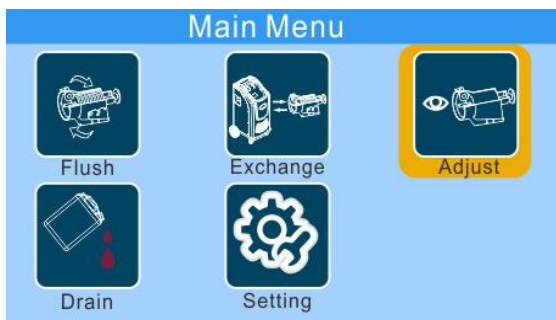

Remarks: When new fluid does not contain enough fluid, machine will automatically make alarm and remind to fill new fluid tank.

Adjust (Decrease)

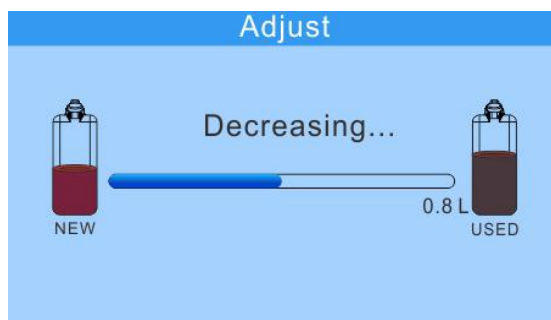
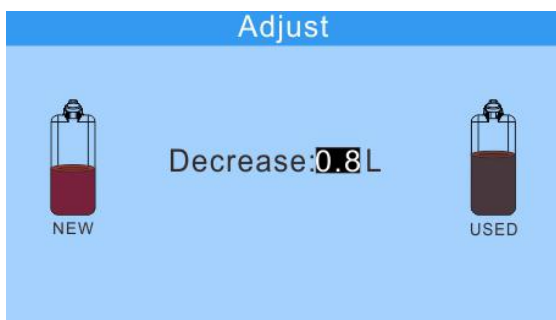
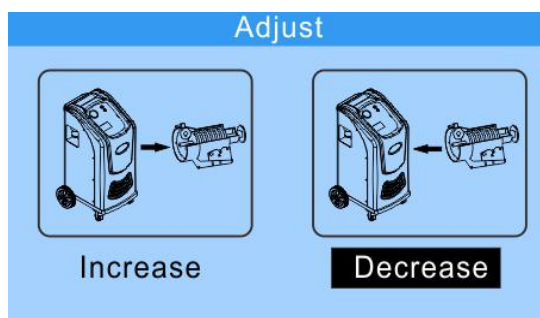
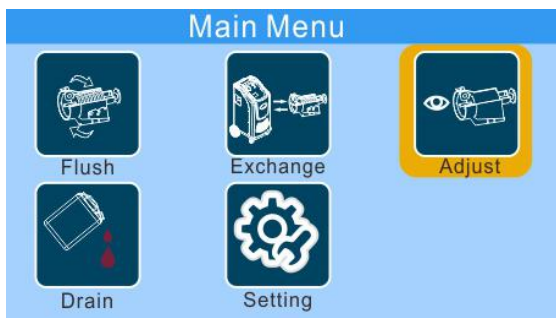

Remarks: When used fluid tank is full, the machine automatically makes alarm and remind to drain used fluid tank.

Drain

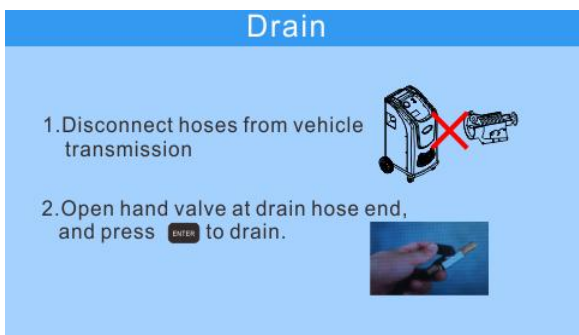
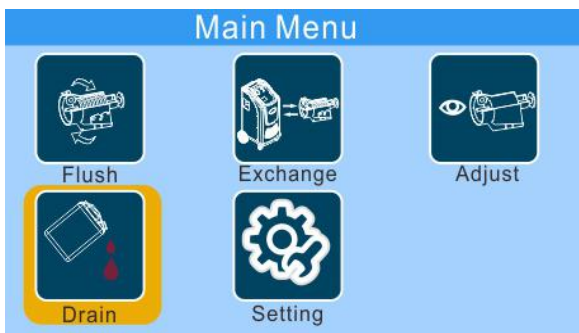

Setting

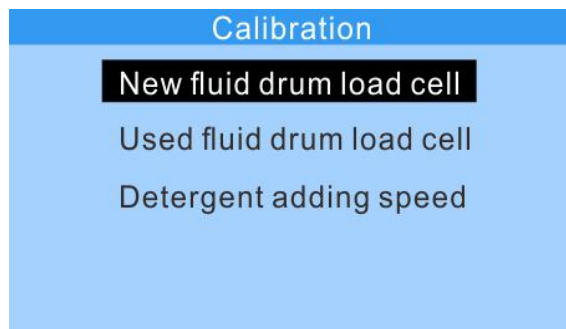
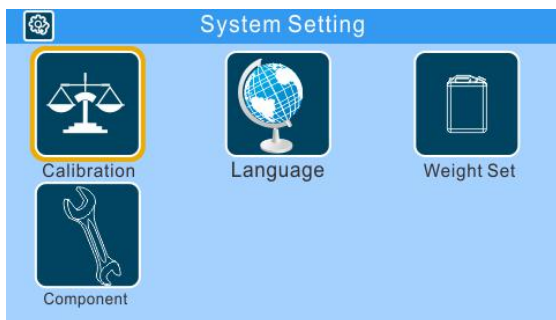
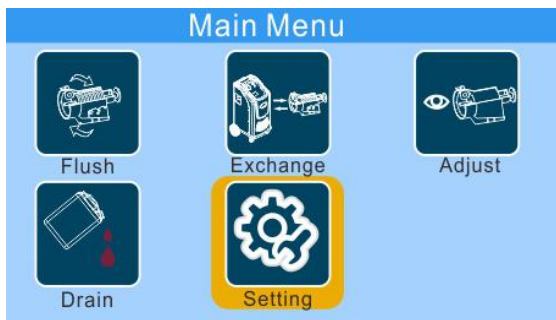

Calibration of new or old fluid drum load cell.

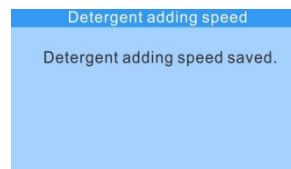
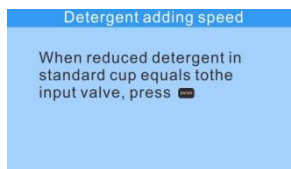
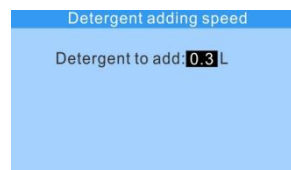
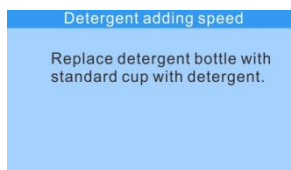
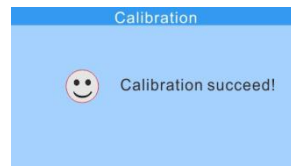
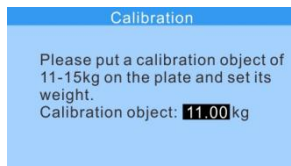
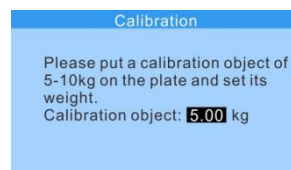
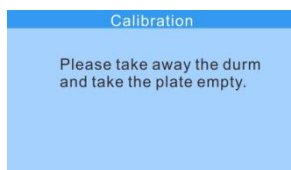

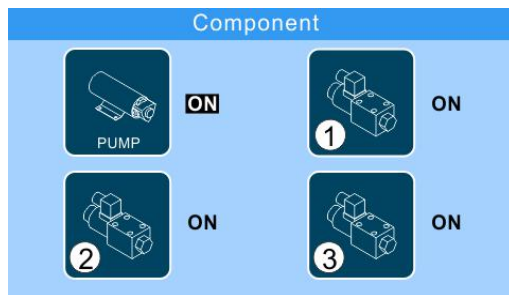
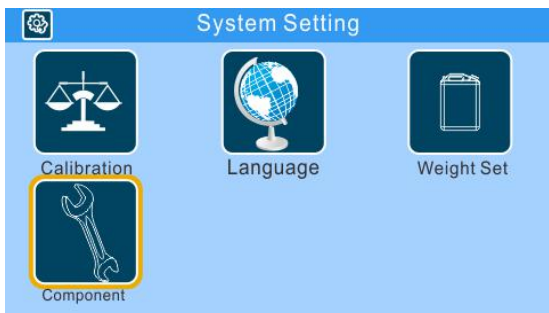
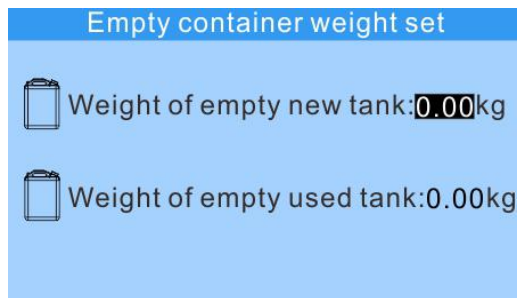

Calibration of detergent adding speed

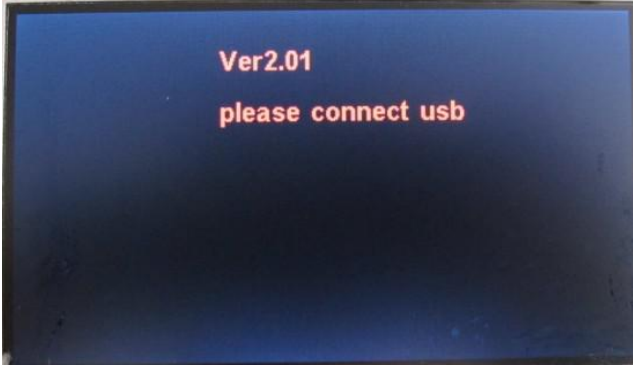
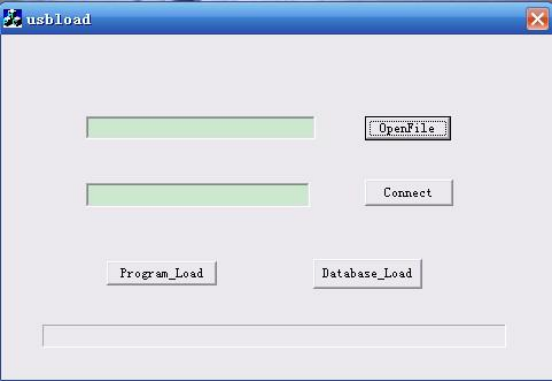
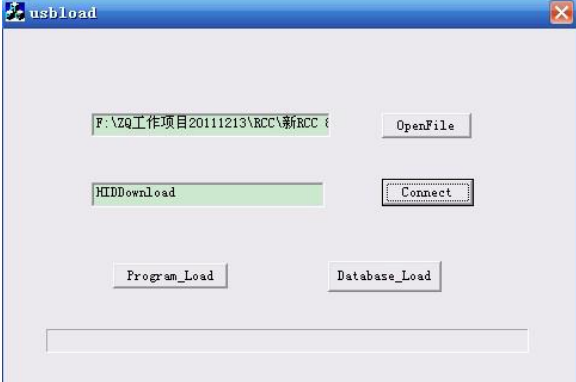

Remarks: Key “  ” for turning on the component, key “  ” for turning off the component.

Update

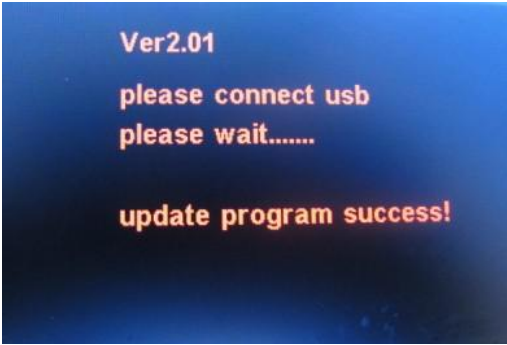
	
<p>Pressing ENTER key, and turn on the machine</p>	<p>The machine indicates to connect USB</p>
<p>Connect the machine with PC through USB port. In PC, run USBload.exe, the PC displays the following message:</p>	<p>Click “OpenFile” to select update to update, e.g. file “102_V2.01” (for main program update) Then click “Connect” the PC displays the following message</p>
	
<p>Click “Program_load” for main program update, the machine displays the following:</p>	<p>In about 1 minute, the machine displays:</p>
	 <p>Turn off the machine and turn it on again, the machine will run the updated software.</p>

Main troubleshooting

Malfunction	Reasons	Solution
LCD no display, can not turn on the machine	1. Power supply cable is not well connected. 2. Fused 3. LCD does not work	1. Fasten the connection of power cable 2. Change the fuse 3. Change the LCD
Volume of new or used fluid is not correct	1. Load cell is not well calibrated 2. PCA or load cell does not work well, or not well connected	1. Calibrate the load cells. 2. Fasten the connection, change the PCA or load cell
Vibration or big noise	Pump does not work well, not tightened, or pipeline near the pump twisted.	Check the pump, connection and installation of the pump.
Any function takes excessively long time	Pipeline abnormal	Check leakage, connection and component (solenoid, non-return valves, block in hoses) etc.

Adaptor list

Item	No.	Art. code	Picture	Size	For car makes	Configuration
1	A01			Φ5/Φ8/Φ10	TOYOTA, MITSUBISHI, LEXUS, HONDA, NISSAN	Standard
2	Φ8/Φ10/ Φ12			Φ8/Φ10/Φ12 2 hose	TOYOTA, MITSUBISHI, LEXUS, HONDA, NISSAN	Standard
3	A03A			M16×1.5	CADILLAC, BMW750: 4HP-22, 4HP-24, A21 MITSUBISHI V6, 3000	Standard
4	A03B			M16×1.5	CADILLAC, BMW750: 4HP-22, 4HP-24, A42	Standard
5	A05A			M18×1.5	EUROPEAN OPEL Vectra, VW Passat	Standard
6	A05B			M18×1.5		Standard
7	A06A			G1/4"	CHRYSLER GRAND VOYAGER, 300	Standard
8	A06B			G1/4"		Standard
9	A10A			UNF1/2-20	FORD, MERCEDES, VOLVO, CHRYSLER	Standard
10	A10B			UNF1/2-20		Standard
11	A11A			Z1/4	FORD, LINCOLN, VOLVO	Standard
12	A11B			Z1/4		Standard
13	A13A			UNF5/8-18	GM, CADILLAC	Standard

14	A13B		UNF5/8-18	GM, CHRYSLER	Standard
15	A14A		UNF5/8-18	FORD, VOLVO	Standard
16	A14B		UNF5/8-18		Standard
17	A20A		UNF1/2-20	FORD	Standard
18	A20B		UNF1/2-20		Standard
19	A43×2		M12× 1.5	GENERAL	Standard
20	A44		M12	GENERAL	Standard
21	A51		Φ8.0 (H)	FORD, LINCOLN, MAZDA, VOLVO	Standard
22	A53		Φ12.5(H)	CHRYSLER, DODGE, FORD FOCUS	Standard
23	A02		Φ9.55(H) Φ12.75(H) Φ15.85(H)	TOYOTA, MITSUBISHI SPACE WAGON GLXI, LEXUS ES300, HONDA, NISSAN	Optional
24	A04A		G1/4"	MERCEDES	Optional
25	A04B		G1/4"		Optional
26	A07A		M18×1.5	EUROPE VECTRA	Optional
27	A07B		M18×1.5		OPEL Optional

28	A08A		UNF1/2-20	GM, LINCOLN, CADILLAC	Optional
29	A08B		UNF1/2-20		Optional
30	A09A		M16×1.5	EUROPE	Optional
31	A09B		M16×1.5	CHRYSLER	Optional
32	A12A		UNF5/8-18	FORD, MERCEDES	Optional
33	A12B		UNF5/8-18	FORD, CADILLAC	Optional
34	A15A		UNF5/8-18	CHRYSLER benxc200, S325i, GM	Optional
35	A15B		UNF5/8-18		Optional
36	A16A		M18×1.5	EUROPEAN	Optional
37	A16B		M18×1.5		Optional
38	A17A A17B		Φ14.95 Φ14.85	EUROPE	Optional
39	A18A		Φ15	SPECIAL VEHICLES	Optional
40	A18B		BoreΦ16		Optional
41	A19A		BoreΦ13		Optional
42	A19B		OuterΦ12		Optional

43	A40		G1/4	SPECIAL VEHICLES	Optional
44	A41		G1/4		Optional
45	A42		M10×1.0	SPECIAL VEHICLES	Optional
46	A45		G1/4	SPECIAL VEHICLES	Optional
47	A46		Φ12	SPECIAL VEHICLES	Optional
48	A47		M14×2.0	SPECIAL VEHICLES	Optional
49	A48		M20×1.5 outer	SPECIAL VEHICLES	Optional
50	A49		UNF3/4-18 outer	SPECIAL VEHICLES	Optional
51	A50		Φ9.5 (H)	GM, BUICK, CHEVROLET, CADILLAC, SAAB	Optional
52	A52		Φ9.5(H)	CHRYSLER, DODGE	Optional
53	A54		Φ6.0(H)	HOSE ADAPTERS	Optional
54	A55		Φ7.5(H)	HOSE ADAPTERS	Optional
55	A56		Φ9.5(H)	HOSE ADAPTERS	Optional
56	A57		Φ12.5(H)	HOSE ADAPTERS	Optional
57	A60			BMW	Optional
58	WJ060001			New BMW	Optional
59	WJ060002			Mercedes-Benz 722.9	Optional

60	WJ060003		VAG (Touareg, Phaeton, Amarok, T5, Q5, Q7, Cayenne, div. A8)	Optional
61	WJ060004		DSG/VAG (Audi, Skoda, VW, Seat)	Optional
62	WJ060005		TF80 Multi (Volvo, Alfa Romeo, Cadillac, Fiat, Ford, Lancia, Land Rover Evoque, Linclon, Mazda, Mercury, Range Rover & Saab)	Optional
63	WJ060006		Powershift (Volvo & Ford)/ VW Touareg adaptor/Dodge Journey	Optional
64	WJ060007		GM TF80 (Opel, GM & Chevrolet)	Optional
65	WJ060009		AISIN: Peugeot/Renault/Citr oen/Fiat/Opel/VAG	Optional
66	WJ060010		ZF 8 HP	Optional
67	WJ060013		ZF 8 HP	Optional
68	BBZ03003 4		HOSE	Optional